

安装尺寸图

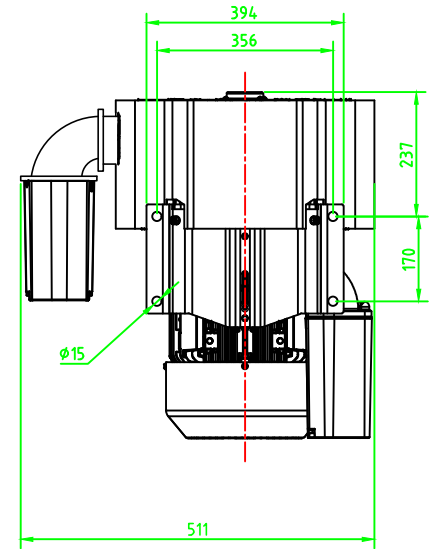
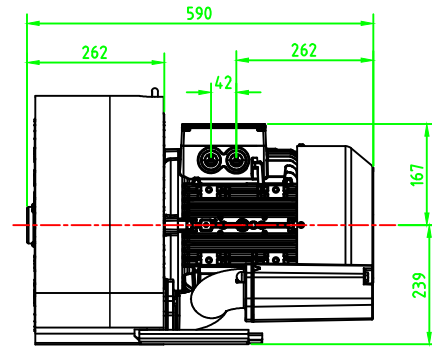
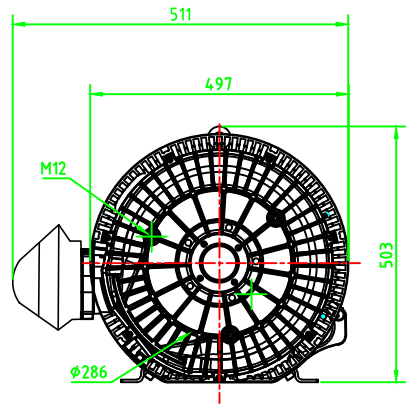

上海德凌实业有限公司

型号	DL-82-X2
功率	7.5KW
电压	380V/50Hz